

ASSEMBLY AND OPERATION OF THE HEATHKIT RADIATION COUNTER MODEL RC-1

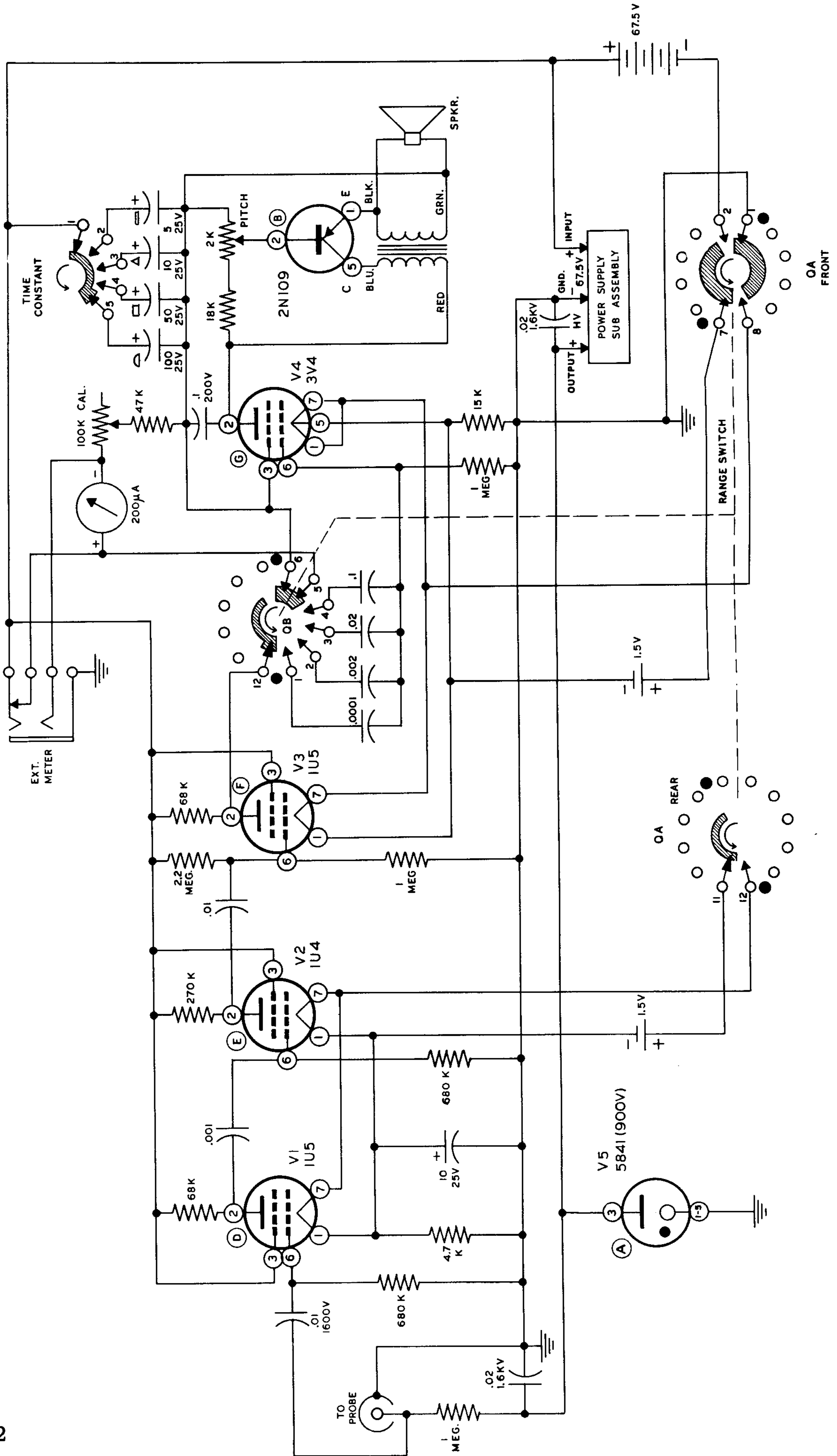

SPECIFICATIONS

Time Constant:.....	0.5, 1, 5 and 10 seconds
Ranges:.....	0-100, 600, 6000 and 60,000 counts per minute 0-.02, .1, 1 and 10 milliroentgens per hour
Meter:.....	Calibrated 4 1/2" 200 μ ampere movement
Probe:.....	Satin aluminum and chrome plated steel probe contains extra sensitive type 6306 Bismuth geiger counter tube.
Speaker:.....	Loudspeaker driven by transistor gives pleasant tones on most sensitive range, no harsh clicks. Muted by panel control.
Calibration:.....	Calibrate control on panel, radioactive sample furnished.
Batteries:.....	1 - 67 1/2 volt B battery (approximately 200 hours to 40 volt end point), intermittent oper- ation. 2 - 1 1/2 volt A batteries (approximately 20 hours to 1 volt end point), intermittent operation.
Tube Complement:.....	1 - 1U4 } Amplification, pulse shaping and 1 - 3V4 } counting tubes. 2 - 1U5 } 1 - 5841 corona regulator tube 1 - 6306 bismuth counter tube 1 - 2N109 transistor (oscillator)
Provision for use of external meter (jack on panel).	
Prewired high voltage power supply assembly.	
Regulated 900 volt DC applied to 6306 tube in probe.	
Coiled cord between probe and instrument, no tangling.	
Cabinet:.....	Aluminum, 9 1/2" high x 6 1/2" wide x 5" deep
Net Weight:.....	6 1/2 lbs.
Shipping Weight:.....	8 lbs.



HEATHKIT MODEL RC-1
RADIATION COUNTER

INSTRUMENT DESCRIPTION

The Heathkit Radiation Counter model RC-1 is a highly developed instrument, designed expressly for the serious prospector. A prewired power supply delivering the required high voltage, coupled with a four tube amplifying and pulse shaping circuit, gives extremely high sensitivity far in advance of most other counters now available, regardless of cost. A large 4 1/2" meter calibrated in counts per minute gives full scale readings from 100 cpm to 60,000 cpm. The meter is also calibrated in milliroentgens per hour (mR/hr) from .02 mR/hr to 10 mR/hr full scale.

An added feature is the use of a loudspeaker for aural monitoring, excited by a transistor oscillator, thus allowing a more pleasing (to the ear) tone than the usual harsh clicks. To further increase its flexibility, the circuit has been so designed to operate accurately and sensitively with the Heathkit Geiger Counter Probe model GC-1, which uses a bismuth counter tube. Using the model GC-1 Geiger Counter Probe with the model RC-1 Radiation Counter comprises an instrument more sensitive but otherwise equal to many now selling for \$250.00 or more. A calibrated, completely safe radiation source is provided with each model RC-1 for spot calibration in the field.

THEORY OF OPERATION

Negative pulses generated in the probe are impressed across the input grid resistor through the .01 μ fd blocking capacitor and are amplified and inverted by V1, appearing across the 68 K Ω plate load resistor. V2 further amplifies and reinverts the signal pulses and injects them into the grid of V3. The two stages of amplification have been designed to have a sensitivity of approximately .1 volt and to limit at an input of .25 volts. This insures a pulse of the proper amplitude for triggering V3, even though the input pulses may vary considerably in height.

V3 and V4 together constitute a mono-stable multivibrator, sometimes called a "one-shot," since it makes one complete cycle for each pulse (trigger). Operation is as follows: The two tubes have a common cathode resistor of 15,000 Ω serving as one leg of the coupling impedance necessary for oscillation and also serving as a source of cut-off bias for V4. The control grid of V3 is returned to a positive point on the voltage divider connected between B+ and ground, causing it to conduct. This conduction causes current flow through the common cathode resistor and the voltage drop across it is sufficient to cut V4 off, since the grid of V4 is returned to ground. This enables the use of a tube with comparatively large emission capabilities as V4 without increasing the B battery drain, since V4 is not allowed to draw current except during the short operating cycle following each input trigger. The RANGE switch connects various precision capacitors between the plate of V3 and the grid of V4 and, in conjunction with the common cathode resistor, provides the necessary cross-coupling to enable multivibrator operation. The capacitors switched between the two tubes determine the period of time the multivibrator will remain in its unstable state. This in turn determines the average current flowing through the meter. The meter is calibrated in both COUNTS PER MINUTE and MILLIROENTGENS PER HOUR. The use of precision capacitors to determine the range and therefore the current for full scale meter deflection enables the use of a single calibration control. Calibration made at one point will hold to within 10% at all points. The calibration control also enables the instrument to be calibrated even when the B battery is quite weak. The overall circuit including the power supply sub-assembly has been designed to operate correctly until the B battery voltage has dropped to 40 volts and/or the filament batteries have dropped to 1 volt or less. This has been done to enable longest battery life commensurate with reliable operation and to preclude the necessity for carrying an excessive number of spare batteries in the field.

An interesting departure from the usual method for aural monitoring has been incorporated in this instrument. A transistor oscillator, using an output transformer as the oscillatory inductance, derives its operating voltage from the voltage drop across a by-passed portion of the plate load resistance for V4, voltage being present only during unstable state immediately following the input trigger pulse. A small loudspeaker is connected directly across the output transformer and reproduces the audio tone generated by the transistor oscillator. This tone may be varied by adjustment of the 2000 Ω PITCH control to that most pleasing to the operator. Since it is an audio tone and not a click, it can be recognized in even the noisiest locations and is invaluable when prospecting in a moving vehicle or aircraft.

Two filament batteries (ordinary flashlight cells) and a 67 1/2 volt B battery (such as is used in most portable radios) supply all operating voltages for the instrument. The power supply sub-assembly derives its operating voltage from the 67 1/2 volt B battery. Its output voltage is sufficiently high (greater than 1200 volts) that it may be regulated at 900 volts for use with the Geiger Counter Probe.

The meter used is a 4 1/2" 200 microampere movement for greatest sensitivity combined with ruggedness. When the instrument is turned OFF, the RANGE switch puts a short across the meter for added protection. A TIME CONSTANT circuit has been incorporated to give added flexibility to the counter, allowing a meter time constant of 1/2 second to 10 seconds. The 1/2 second position of the TIME CONSTANT switch is used when moving over the ground rapidly and the 10 second position is used when checking ore samples for the greatest accuracy.

OPERATION OF THE CORONA REGULATOR TUBE (Courtesy of Victoreen Instrument Company)

The Corona Voltage Regulator tube exhibits many unique virtues when properly used to regulate the output voltage of a high voltage, low current power supply. Like any other type of regulator, it can be a tremendous source of annoyance when improperly used. Among its virtues are its simplified circuits, low cost, good regulation, low power consumption, small spread between starting and operating voltages, and its ability to regulate against variations both in load current and input voltage. It is also mechanically rugged, supplies its own reference, has long operating life and a relatively wide range of operating temperatures.

Since the operation of a corona tube is not widely understood, a simplified discussion of its behavior is appropriate.

In general, it may be stated that when two coaxially positioned cylindrical electrodes are enclosed in a gas-filled envelope and a DC potential is applied between them in such a direction that the central electrode is positive with respect to the outer, the unit may be considered as a variable resistor which is very current sensitive. The volt-ampere relations will exhibit three distinctly different regions, as illustrated in Figure 1.

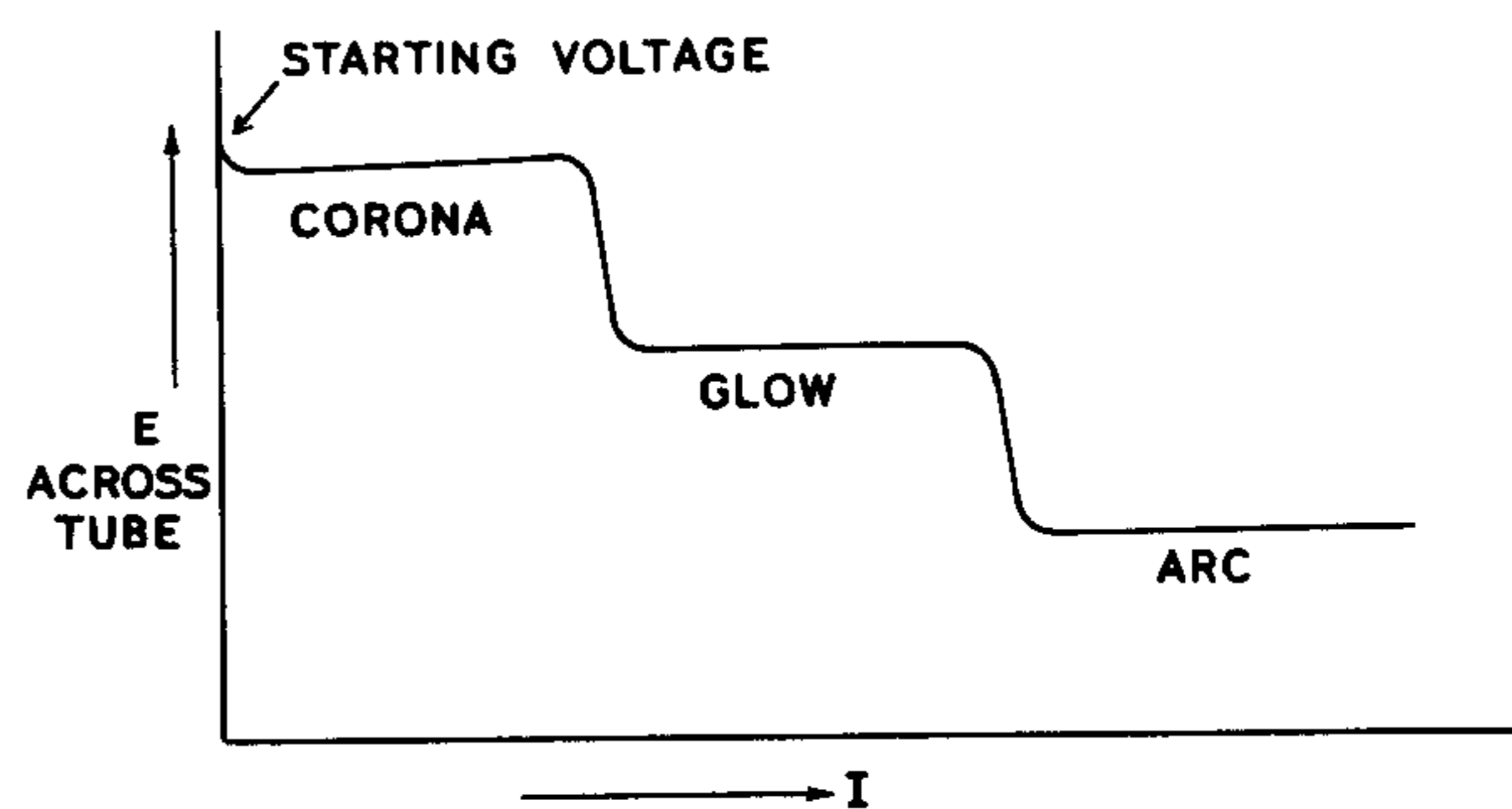

Figure 1

The exact values of voltage and current for any one of these regions are determined by electrode dimensions as well as gas nature and pressure, and other considerations. When these parameters are selected to provide a useful corona region, the other two regions become limited. Similarly, if the tube is designed for the glow region operation, the characteristic curve may pass through the corona region so quickly as to be hard to identify.

Roughly speaking, these three areas of operation may be distinguished by the location of any visible light. The corona will appear around the anode, while the glow appears adjacent to the cathode. The arc is visible between the two.

Obviously corona tubes are useful for high voltage-low current application, glow tubes for medium voltage-medium currents, while the arc involves higher orders of current and lower voltage drops.

As a voltage regulator, the corona tube is connected across the load whose voltage is to be regulated, in series with the resistor, in the same manner as the more familiar glow tube regulator would be used.

The supply voltage is then divided between the series resistor and the parallel combination of regulator and load, and the regulator tube tends to hold the voltage across the load constant. For circuit analysis, the tube may be considered as a constant voltage source (whose value is the nominal operating voltage of the regulator) in series with a resistance (computed from the published regulation curve). For example, the type 5841, regulating at 900 volts with a regulation of 1.5% between 5-50 μ a may be considered as a 900 volt battery in series with a resistor.

From this equivalent circuit, other parameters may be established. In most cases, the variations in load are predetermined by the application, and the variations in unregulated supply are imposed by its nature, so the problem becomes one of evaluating the series resistor necessary to produce the required degree of regulation. It should be pointed out that while high values of series resistance tend to produce the best per cent regulation, they also produce the smaller values of regulator tube current and vice versa. The circuit used in the Heathkit Radiation Counter tends to keep the operation of the tube as near the center of the corona region as possible, since transients in the supply or load might cause the momentary operation of the tube below the corona region (temporary extinction) or above the corona region (glow and arc). In either case, serious instability would result.

When the supply voltage has appreciable ripple and/or large transients, such as are unavoidable in the vibrator or fly-back type, considerable filtering is necessary between the supply and the regulator. The positive peaks of the waveform of the voltage at the resistor in series with the regulator must not be permitted to drive the corona into the glow or arc region nor must the negative peaks be permitted to fall below the striking voltage of the regulator. Either condition may introduce very objectionable AC components into the load.

The corona regulator greatly aids the filter in attenuating AC components. The AC components ahead of the series resistor are attenuated at the load by the voltage divider action of the resistor in series with the parallel combination of the load and the dynamic resistance of the corona. Since the ratio of the series resistor to the parallel combination is usually high, the degree of attenuation of ripple is also high.

Due to the relatively small spread between striking and operating voltage, its relatively low dynamic resistance (300 K Ω at 50 μ amperes), its relatively short ionizing and deionizing time, etc., the corona regulator makes a very poor relaxation oscillator when confined to the corona region. For this reason, small capacities may safely be placed across it to improve filtering. However, care must be exercised, lest a transient should inadvertently cause the tube to momentarily pass sufficient current to swing it to the glow or arc region, which would dump the entire charge of the shunt capacitor into the tube and permanently damage it, as well as temporarily impairing its regulation.

Like the glow tube, there is a minimum current required to sustain the corona in a stable condition, but unlike the glow tube, the corona tube may satisfactorily operate in its unstable low current area if by-passed with a capacitor to relieve the transients produced in this region. Adequate filtering ahead of the regulator is required for this type of operation and the degree of regulation may be slightly impaired when operating below the published minimum current. See Figure 2.

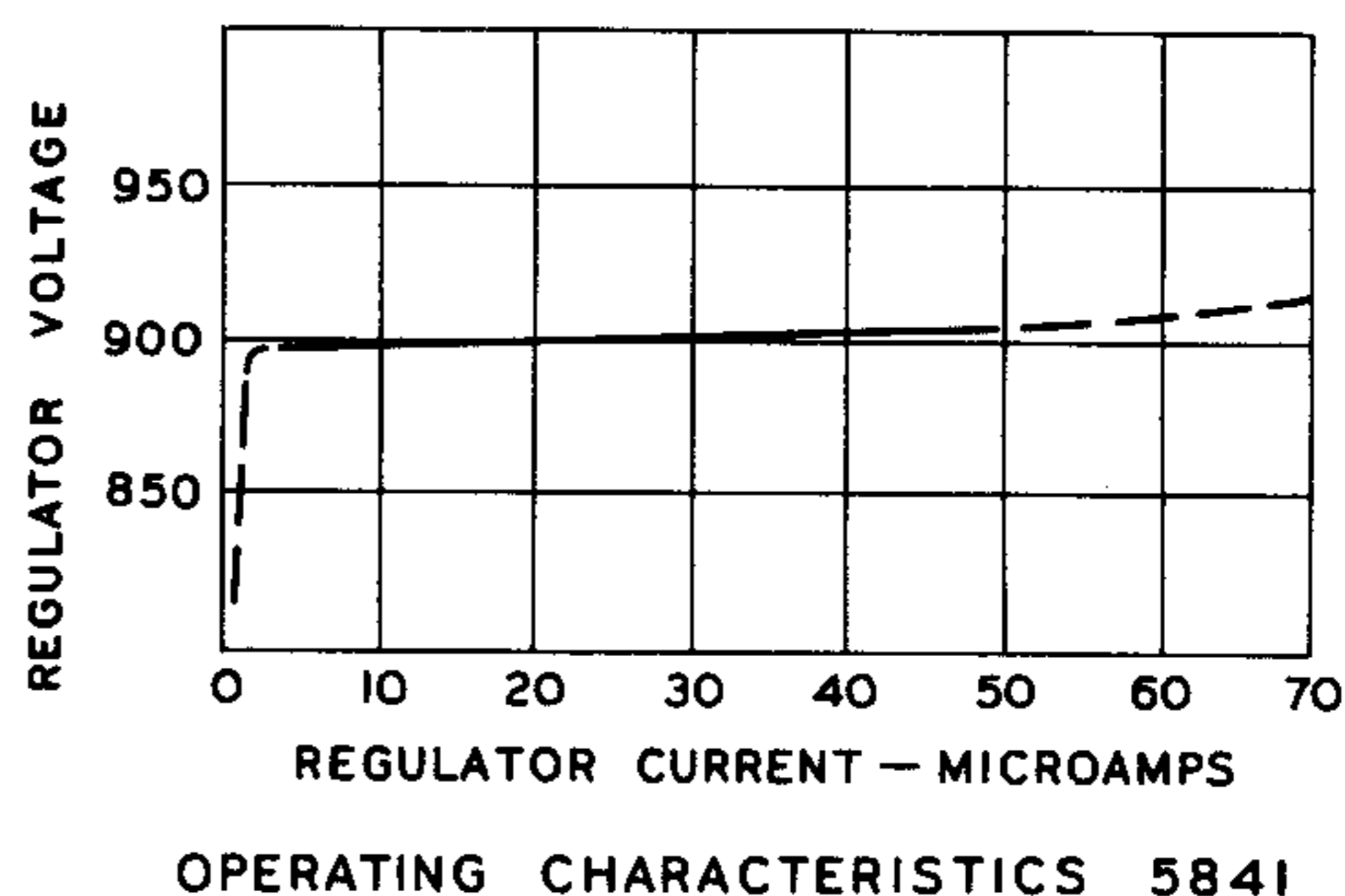

Figure 2

TYPE 6306 THYRODE TUBE

A thyrode counter tube is a gas diode designed to produce an electrical pulse when its sensitive volume is penetrated by an ionizing particle.

The ions and electrons produced within the tube by the penetrating ionizing particles are accelerated by the electrode potential and produce other ions. In this manner, the discharge spreads throughout the tube. The electrons are collected rapidly and account for the rise time of the pulse.

The heavy ions of the quench gas form a sheath around the anode (where the field strength is strongest) and move outward toward the cathode, sweeping the field clear of electrons and thus quenching the discharge. This accounts for the slower (relative to rise time) decay time of the pulse and the smaller pulses as shown in Figure 3.

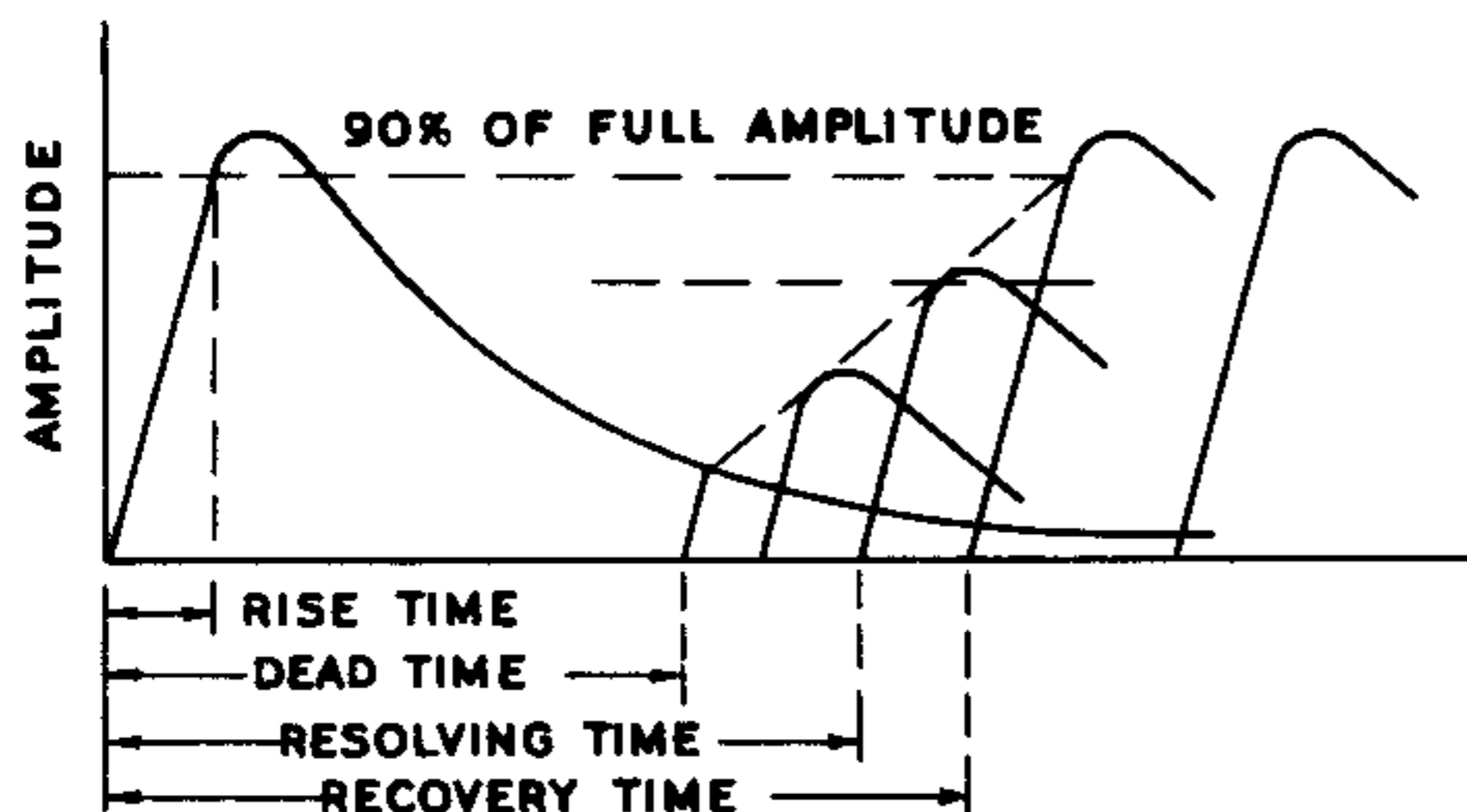

Figure 3

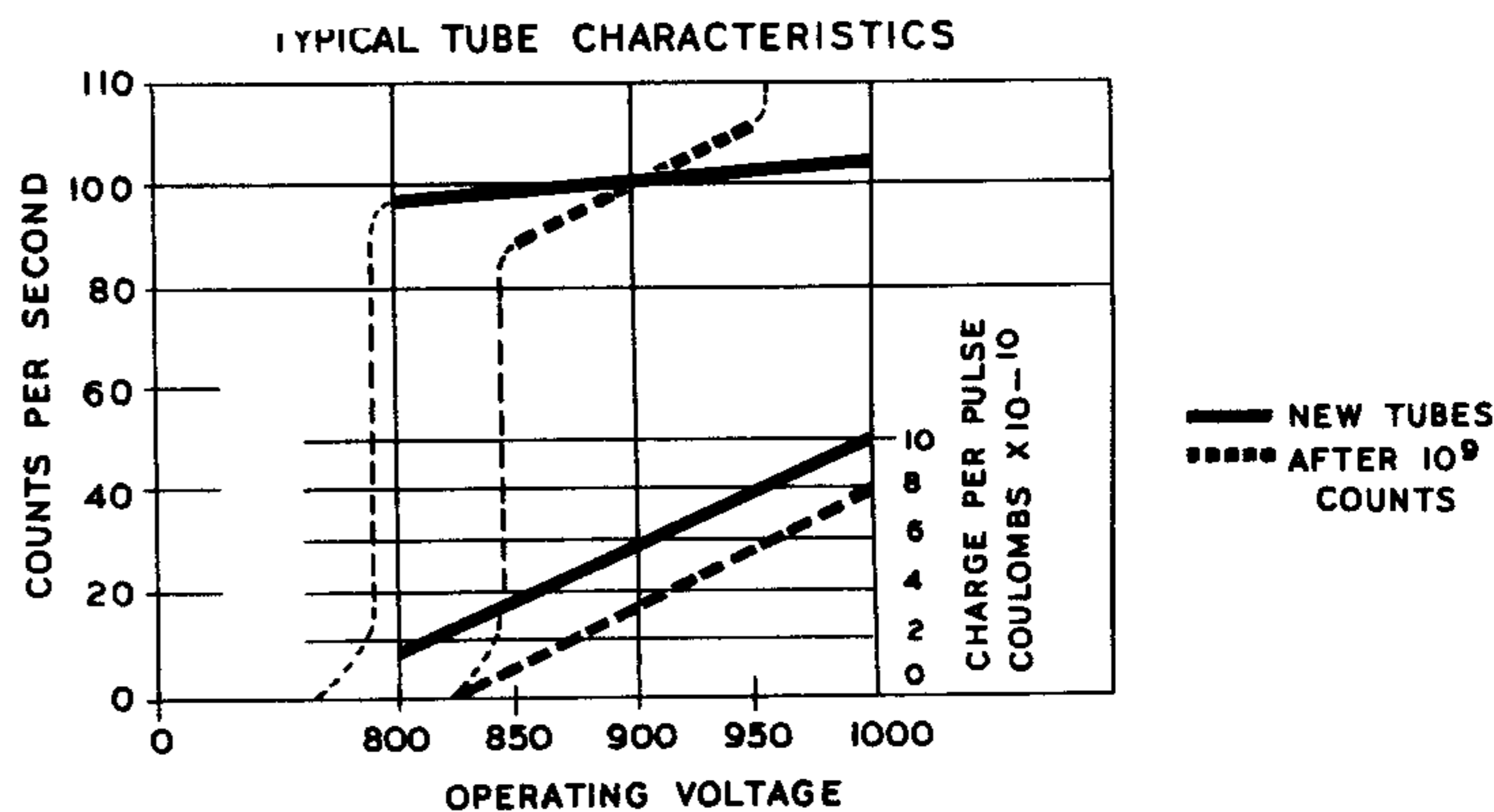

Figure 4

Counter tubes are classified according to the type of radiation which they are designed to measure, as indicated by their wall thickness and material. The 6306 tube used in the Geiger Counter Probe model GC-1 is designed for accurate gamma counting in this instrument. The aluminum shell, although only 0.11 mm thick, is very strong and the tube will operate satisfactorily when accidentally dented.

SPECIFICATIONS - GEIGER COUNTER PROBE

Background:.....	60-80 cpm
Plateau:.....	150 volts
Slope:.....	5%/100 volts
Life (counts):.....	10 ⁸
Sensitivity:.....	Beta, Gamma
Recovery Time:.....	100 μ sec
Life Test End Point:.....	20%/100 volts

NOTES ON ASSEMBLY AND WIRING

The Heathkit Radiation Counter model RC-1, when constructed and used in accordance with the instructions in this manual, is a high quality instrument capable of many years of trouble-free service. Therefore, we urge you to assemble the kit carefully. Do not hurry the work and you will be rewarded with a greater sense of confidence in your ability and in your new Radiation Counter.

This manual is supplied to assist and guide you in every way possible to complete the kit with a minimum possibility of error. Each component has been identified pictorially at the rear of the manual and color codes and numerical values are specified each time a coded component is to be used. Elaborate pictorial diagrams and "step-by-step" wiring instructions are included to help you construct your kit with the greatest facility.

We suggest that you take a few minutes now and read the entire manual through before any work is started. This will enable you to proceed with the work much more rapidly when construction is begun. The large fold-in pictorials are handy to attach to the wall above your work space and their use will greatly simplify construction of this kit. These diagrams are also reproduced in smaller size within the manual. We suggest that you retain the manual in your files for future reference, both in the use of the Radiation Counter and for its maintenance.

- (✓) Plug the remaining miniature tubes in the proper sockets. Be sure the tubes are plugged into the proper socket, otherwise the instrument will not operate properly and tubes or other components may be damaged.
- (✓) Mount rubber feet in the four large holes near the corners of the bottom of the cabinet. See Figure 11-C.
- (✓) Insert the instrument into the cabinet so the three small holes in the cabinet bottom line up with matching holes in the chassis and Z bracket. Be sure the edges of the panel are in place on the outside of the cabinet.
- (✓) Fasten the instrument in the cabinet using three self-tapping screws through the holes in the bottom of the cabinet.

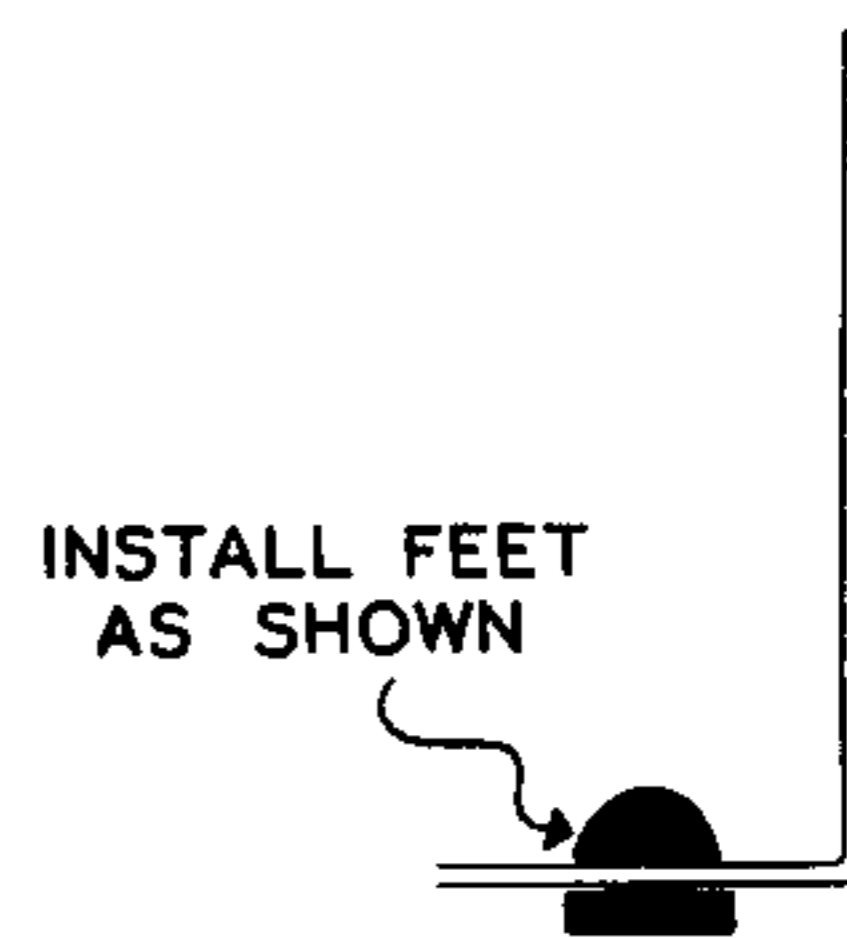

Figure 11- C

This completes the construction of your model RC-1 Radiation Counter.

CONSTRUCTION OF THE GEIGER COUNTER PROBE MODEL GC-1

Refer to Pictorial 7 on Page 21. This "exploded view" is designed to assist you to rapidly complete construction of the kit.

- () Prepare the cable ends as shown and attach the coaxial plug to the short end.
- () Feed the long end of the cable through the handle as shown. If necessary, lubricate with soap.
- () Tie a knot very close to the prepared end.
- () Solder the outer (shield) conductor to the retaining ring as shown and cut off any excess.
- () Insert the retaining ring into the handle and seat it in the groove provided, pulling gently on the cord to seat the knot against the inner flange of the handle.
- () Drop the socket over the center conductor and solder this center conductor. Push the socket in against the retaining ring.
- () Insert the thin plastic into the probe housing.
- () Remove the 6306 tube from its carton and insert gently into the socket. **DO NOT HANDLE THIS TUBE WITH THE FINGERS EXCEPT ON THE BASE OR FLANGE OR THE THIN WALL MAY BE CRUSHED.**
- () Slip the probe housing over the 6306 tube and screw carefully on the handle. Tighten securely.

This completes construction of your Heathkit Geiger Counter Probe model GC-1.

TEST AND CALIBRATION

Check over your wiring for errors, poor or unsoldered joints and wire ends or other foreign matter lodged in the wiring. Be sure all tubes and the transistor are plugged into the proper sockets. See that the 1.5 volt batteries are held solidly in their clamp and that they are properly polarized. Make sure the B battery connector is in place.

Connect the probe to the probe socket. Advance the RANGE switch to the 600 CPM range and the TIME CONST. switch to 5 SEC. A rapid, uniform clicking will be heard coming from the

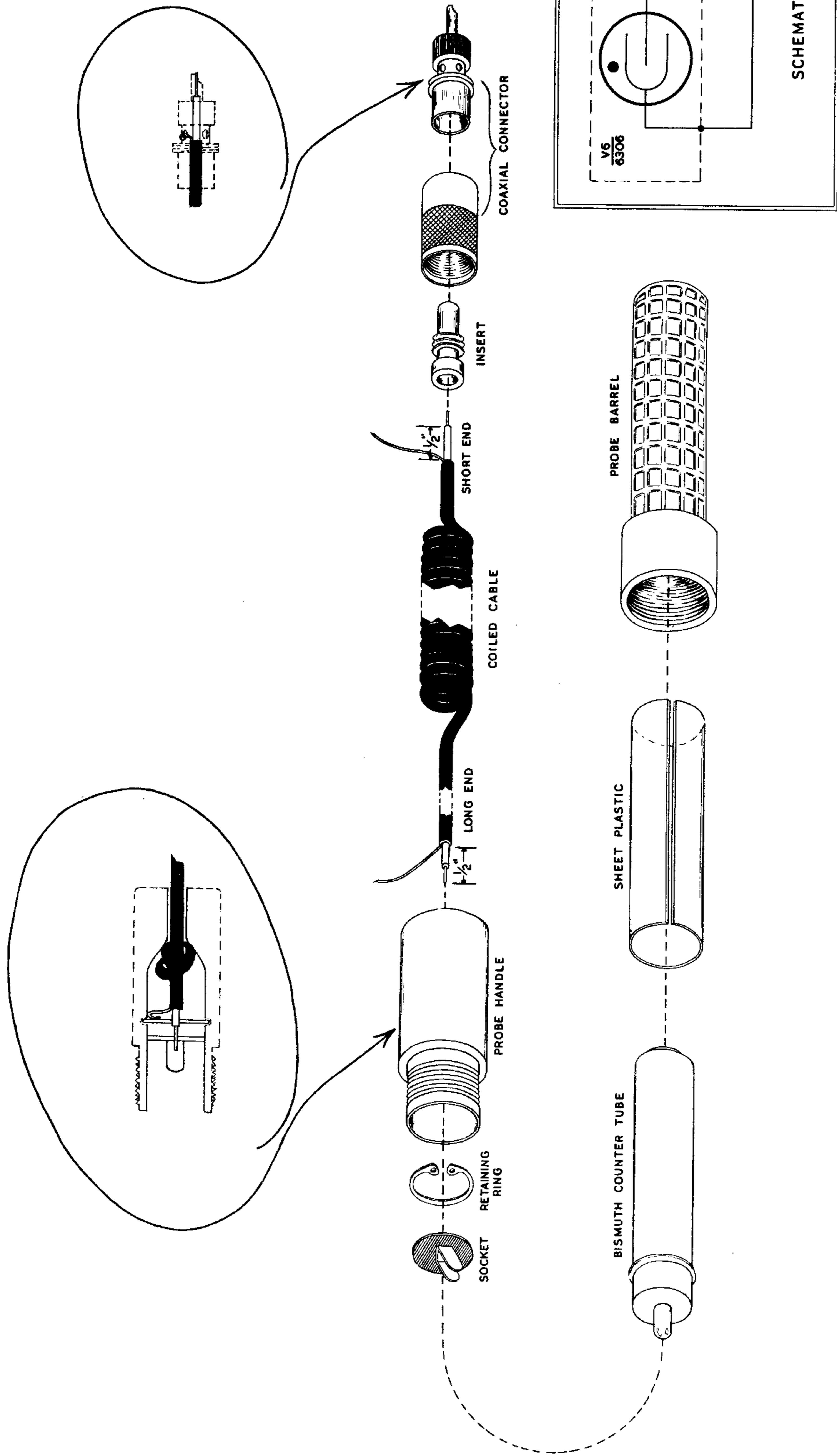

PICTORIAL 7

power supply unit. This is normal and indicates the power supply is working. The meter needle will be indicating above zero at this time; the exact reading is immaterial. If any sound is coming from the speaker, rotate the PITCH control knob fully counterclockwise. Place the radioactive calibrating sample on a clean surface. Lay the probe against the calibrating sample as shown.

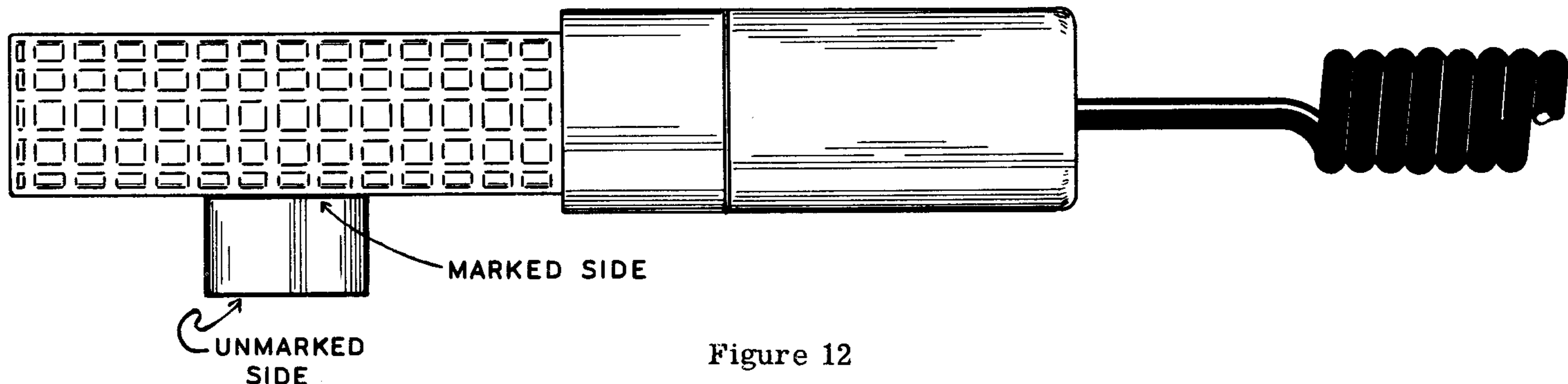

Figure 12

Place the RANGE switch in the X10 position and adjust the CALIBRATE control with a screwdriver until the meter reading is 1 MR/hr. Screw the plastic cap nut over the CALIBRATE control shaft. Remove the sample to a point several feet from the probe. Advance the RANGE switch to the 100 CPM position. Advance the TIME CONST. control to the 10 SEC. position. The reading on the meter is the normal background for your present location. Using the GC-1 probe, a normal background reading will most likely be 60-80 cpm. It is impossible to give the specific figure for "normal" background count, since the background reading varies from place to place. The figures given above are only approximations, at best.

IN CASE OF DIFFICULTY

Recheck your wiring and connections; better still, have a friend do it for you, since he may readily notice an error consistently overlooked. If the wiring is correct and all connections are properly made and soldered, it is first suggested that the tubes be checked. Since battery tubes are used, this should be done on a tube tester. **DO NOT USE AN OHMMETER TO TEST FOR FILAMENT CONTINUITY ON A BATTERY TUBE, SINCE THE DELICATE FILAMENT MAY VERY LIKELY BE BURNED OUT IN THE PROCESS.** If the four miniature tubes are good and the power supply is clicking rapidly, check the voltages as tabulated in the chart below.

TUBE TYPE	Pin 1	Pin 2	Pin 3	Pin 4	Pin 5	Pin 6	Pin 7
V1 1U5	+2.75	+41	+67.5	0	NC	NS	+4.2
V2 1U4	+2.75	+67.5	+67.5	0	NC	NS	+4.3
V3 1U5	+20	+26	+67.5	0	NC	+20	+21
V4 3V4	+21	+67.5	+67.5	NC	+21	NS	+21

Conditions:

- RANGE:..... In 6000 CPM (X10) position
- TIME CONST.:...10 SEC
- PITCH:.....Clockwise
- Probe:.....Not attached to instrument
- Meter:..... DC VTVM 11 megohm input inpedance
- Batteries:..... Fresh batteries installed

All voltages are DC and are measured with respect to the chassis.

NC - no connection.

NS - not significant.

All voltages should be within $\pm 25\%$ of those listed in the chart.

NOTE: DO NOT ATTEMPT TO MEASURE THE DC VOLTAGE AT PIN 3 OF SOCKET A NOR THE VOLTAGE AT THE OUTPUT OF THE POWER SUPPLY OR AT THE PROBE CONNECTOR. THE CORONA REGULATOR TUBE AND POWER SUPPLY MAY BE DAMAGED BY SUCH MEASUREMENT AND NO SATISFACTORY VOLTAGE INDICATION WILL BE INDICATED ON THE METER DUE TO THE EXTREMELY HIGH SOURCE IMPEDANCE OF THE POWER SUPPLY. HIGH (200 MILLION OHMS) IMPEDANCE VOLTAGES SUCH AS THESE MAY BE MEASURED ONLY WITH AN ELECTROMETER VOLTMETER FOUND ONLY IN A FEW CERTAIN LABORATORIES.

Depending on local lighting conditions, you may or may not see the glowing filaments in the four miniature tubes. Under no circumstances should a glow be noted in the corona regulator tube, as this indicates a defective tube or the likelihood of trouble in the high voltage circuits.

A series of high pitched tones or a roaring sound, depending on the range used, emanating from the speaker indicates proper operation of the transistor, and of the entire unit when the probe is attached. With no probe attached and all tubes and the transistor in place, there should be no sound from the speaker after the first minute of operation. Such sounds in this case would indicate either wiring errors or poor lead dress, which must be corrected. In the event continued difficulties are encountered, please refer to that section of this manual entitled SERVICE.

OPERATION

Attach the probe to the instrument and rotate RANGE switch to the proper position. Place TIME CONST. switch in the 5 SEC. position and advance the PITCH control to about mid-range. A deflection of the meter will be noted and "beep" tones or roaring sounds, depending on the range in use, will be heard coming from the speaker. Assuming there is no radioactive material in the immediate vicinity, meter reading will be the background count and is caused by cosmic rays and stray gamma radiation. It is an indication that your radiation counter is operating normally.

Advance the TIME CONST. switch to 10 SEC. and note that the reading on the meter is steadier. Reduce the TIME CONST. to 1 SEC. and note the increasing fluctuation of the meter. Reduce the TIME CONST. to .5 SEC. The meter should fluctuate wildly and may occasionally go off scale. The choice of time constant has been made available so that you may use a time constant appropriate to your speed in covering the area in which you are prospecting. The shorter time constants are advantageous when covering ground rapidly, as when in a vehicle or mounted on a horse or burro. The long time constants enable a more accurate reading to be made when checking ore samples or when grid prospecting a suspected anomaly. When prospecting, a time constant sufficiently short to enable the instrument to indicate any change in the normal background count is normally used.

In any instrument of this type, a calibrated meter is primarily a convenience, since specific absolute readings have no meaning until referred to a normal (for that area) background count. Therefore, it is the magnitude of difference between two readings and not the readings themselves, which have meaning for the prospector. An increase of 10% or more over background count, while not necessarily indicating the presence of a marketable uranium deposit, is suspicious and the area should be investigated thoroughly before proceeding.

Uranium is found in a great variety of materials. Nearly 100 species may be listed as uranium minerals and we may list more than 200 if we count all the minerals in which uranium occurs commonly but is not an essential constituent.

Most uranium minerals are black or bright shades of green, yellow and orange. These are most accurately identified and their uranium content determined by laboratory methods, but two criteria either singly or together aid in identifying them in the field. First, along with thorium and some potassium minerals, uranium minerals are radioactive and generally can be detected and measured by a Geiger or scintillation counter. Second, some uranium minerals, particularly the bright colored ones, fluoresce under an ultraviolet lamp.

The common uranium oxides are uraninite and its colloform variety, pitchblende. These oxides are black or brown and have specific gravities of 5 to 9.

The common uranium phosphates are autunite (yellow) and tobernite (green). The presence of these minerals suggest that primary uranium minerals may be found at depth. Two uraniferous vanadates, carnotite and tyuyamunite, are important constituents of uranium deposits on the Colorado plateau. Both are a bright mustard or canary yellow.

Of all the uranium minerals, only uraninite, pitchblende, davidite, brannerite, carnotite, tyuyamunite, autunite, tobernite, uranophane and schroekingite generally form minable deposits under present economic conditions. The other uranium minerals, however, are commonly associated with uranium ores and are useful clues to the possible presence of uranium deposits. Certain plants, like juniper and saltbrush, take up uranium from the soil if any appreciable amounts are present. Uranium content of the plant will be 2 or 3 parts per million and indicates the presence of uranium ore within 50 feet of the surface.

In selecting an area for prospecting, two approaches may be distinguished. One, the observational or "uranium is where you find it" approach and two, the analytical or "uranium is where it ought to be" approach. It will be no surprise to economic geologists to learn that most of the producing uranium deposits in the world were found through the "uranium is where you find it" approach, as were some of the recent discoveries in this country. It will pay both prospectors and geologists to continue to look for uranium wherever and whenever they have opportunity, regardless of whether or not the specific area is supposed to contain uranium deposits.

The numerous occurrences of pitchblende veins in the Western States have about the same relation to the occurrence of larger, minable deposits as smoke does to fire. It is well known that for every large oil field, there are several smaller ones and the same relationship holds with respect to mineral deposits. Further exploration in the vicinity of known occurrences seems sure, therefore, to reveal some minable deposits and additional prospecting in granitic and metamorphic terranes may well turn up important new districts. The possibilities for discovering additional important sandstone deposits seem particularly promising, both within the Colorado plateau and elsewhere in the Western States. It seems well worthwhile to examine all lenticular permeable formations in the western area, whether they are known to contain ore or not. The oldest formation of this type in any given district, particularly the parts where permeable facies interfinger with inpermeable ones, seem especially promising.

It is beyond the scope of this manual to teach geology and the science of prospecting. However, sufficient material to guide the beginner and assist the professional prospector has been included. Several very excellent sources of study material have been suggested in the BIBLIOGRAPHY. Your public library may have many of these books and many others equally good, which have not been listed due to lack of sufficient space.

BIBLIOGRAPHY

U.S. Government Publications, Supt. of Documents, U.S. Govt. Printing Office, Washington 25, D.C.:

- Prospecting for Uranium; A. E. C., 1951, 55 ¢. Valuable, but slightly outdated.
- Prospecting with a Counter; A. E. C., rev. 1954, 30¢. A well written and valuable book.
- Selected Readings on Atomic Energy; A. E. C. 1954, 15¢. A listing of pertinent books and periodicals.
- Selected Papers on Uranium Deposits in the U. S. U. S. G. S., Cir. 220, free. Discussion of primary and secondary deposits of uranium bearing ore deposits in different rock formations. Very good maps and bibliography.

Books available from the publisher:

- Uranium Official Yearbook; New Science Inst., 330 South Beverly Drive, Beverly Hills, Calif. 1955, \$2.00. An extremely valuable book, comprehensive in scope.
- Nininger, Robt. D.; Minerals for Atomic Energy; Van Nostrand, New York City, 1954, \$7.50
This book is indispensable to the serious prospector. It discusses uranium, thorium and beryllium thoroughly and is world wide in coverage.
- Proctor, Hyatt, Bullock; Uranium - Where it is and How to Find It; Eagle Rock Publishers, Box 1581, Salt Lake City, Utah. Written by experts for the beginning prospector with emphasis on the Colorado Plateau.

Excellent maps may be obtained from the following sources:

- U. S. Geological Survey, Federal Center, Denver, Colorado or Washington 25, D. C.
Petroleum Information, Continental Oil Bldg., Denver, Colorado. This firm has excellent uranium maps of the Rocky Mountain area, having been engaged in mapping that area since 1928.

REPLACEMENTS

Material supplied with Heathkits has been carefully selected to meet design requirements and ordinarily will fulfill its function without difficulty. Occasionally improper instrument operation can be traced to a faulty tube or component. Should inspection reveal the necessity for replacement, write to the Heath Company and supply all of the following information:

- A. Thoroughly identify the part in question by using the part number and description found in the manual parts list.
- B. Identify the type and model number of kit in which it is used.
- C. Mention the order number and date of purchase.
- D. Describe the nature of defect or reason for requesting replacement.

The Heath Company will promptly supply the necessary replacement. Please do not return the original component until specifically requested to do so. Do not dismantle the component in question as this will void the guarantee. If tubes are to be returned, pack them carefully to prevent breakage in shipment as broken tubes are not eligible for replacement. This replacement policy does not cover the free replacement of parts that may have been broken or damaged through carelessness on the part of the kit builder.

SERVICE

In event continued operational difficulties of the completed instrument are experienced, the facilities of the Heath Company Service Department are at your disposal. Your instrument may be returned for inspection and repair for a service charge of \$5.00 plus the cost of any additional material that may be required. **THIS SERVICE POLICY APPLIES ONLY TO COMPLETED INSTRUMENTS CONSTRUCTED IN ACCORDANCE WITH THE INSTRUCTIONS AS STATED IN THE MANUAL.** Instruments that are not entirely completed or instruments that are modified in design will not be accepted for repair. Instruments showing evidence of acid core solder or paste fluxes will be returned not repaired.

The Heath Company is willing to offer its full cooperation to assist you in obtaining the specified performance level in your instrument. Factory repair service is available for a period of one year from the date of purchase or you may contact the Engineering Consultation Department by mail. For information regarding possible modification of existing kits, it is suggested that you refer to any one or more of the many publications that are available on all phases of electronics. They can be obtained at or through your local library, as well as at any electronic outlet store. Although the Heath Company sincerely welcomes all comments and suggestions, it would be impossible to design, test, evaluate and assume responsibility for proposed circuit changes for specific purposes. Therefore, such modifications must be made at the discretion of the kit builder according to information which will be much more readily available from some local source.